



**F.P.Z. effepizeta s.r.l.**

Via F.lli Cervi 16/18  
20049 Concorezzo - (MI) - ITALIA  
Tel. +39 039 604 1820  
Fax +39 039 604 1296  
www.fpz.com

LATERAL CHANNEL BLOWERS - COMPRESSORS

**SCL K03 / K04 / K05 / K06**

**MS SERIES - MOR RANGE**

SN 1870-6 1/2

**TECHNICAL CHARACTERISTICS**

- Aluminium alloy construction
- Smooth operation
- High efficiency impeller
- Maintenance free
- Mountable in any position

**OPTIONS**

- Special voltages (IEC 38)
- Surface treatments

Possible alternative positions,  
please refer to drw SI 1835

Dimensions in mm.  
Dimensions for reference only

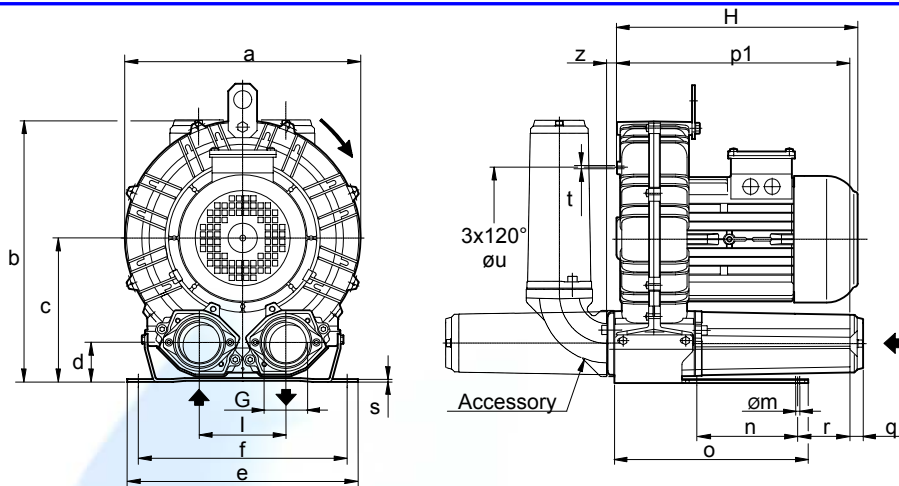

Model	a	b	c	d	e	f	G	l	m	n	o	p1	q	r	s	t	u	z
K03-MS	241	268	147	43	230	205	G 1" 1/4	86	10	83	142	205	18	75	4	M6	140	12
K04-MS	285	315	172	49	255	225	G 1" 1/2	102	12	95	171	222	18	70	4	M6	175	18
K05-MS	327	365	200	54	320	260	G 2"	120	15	115	265	320	18	98	4	M8	200	19
K06-MS	376	393	205	54	325	290	G 2"	125	15	140	272	334	18	85	4	M8	240	19

Model	Maximum flow m³/h		Installed power kW		Maximum differential pressure Δp hPa ( mbar )		Noise level Lp dB (A) (1)		Overall dimensions H mm	Weight Kg
	50 Hz 2900 rpm	60 Hz 3500 rpm	50 Hz 2900 rpm	60 Hz 3500 rpm	50 Hz 2900 rpm	60 Hz 3500 rpm	50 Hz 2900 rpm	60 Hz 3500 rpm		
	K03-MS	74	89	0.37	0.43	130	120	59.7		
K04-MS	137	166	0.55	0.63	150	170	60.0	62.0	241	12.0
			0.75	0.9	140	120	62.6	64.6	282	15.8
			1.1	1.3	200	175	62.8	64.8	282	16.5
K05-MS	219	265	1.5	1.75	250	250	63.0	65.0	310	19.5
			1.1	1.3	130	100	68.2	70.2	307	22.5
			1.5	1.75	175	160	68.5	70.5	307	23.5
			2.2	2.55	270	260	68.8	70.8	330	26.5
K06-MS	304	366	3.0	3.45	300	350	69.1	71.1	375	30.5
			2.2	2.55	180	150	71.0	73.0	367	31.2
			3.0	3.45	250	220	71.3	73.3	367	32.5
			4.0	4.6	340	325	71.6	73.6	367	35.2

(1) Noise measured at 1 m distance with inlet and outlet ports piped, in accordance to ISO 3744.

- For proper use, the blower should be equipped with inlet filter and safety valve; other accessories available on request.
- Ambient temperature from -15° to +40°C.
- Specifications subject to change without notice.

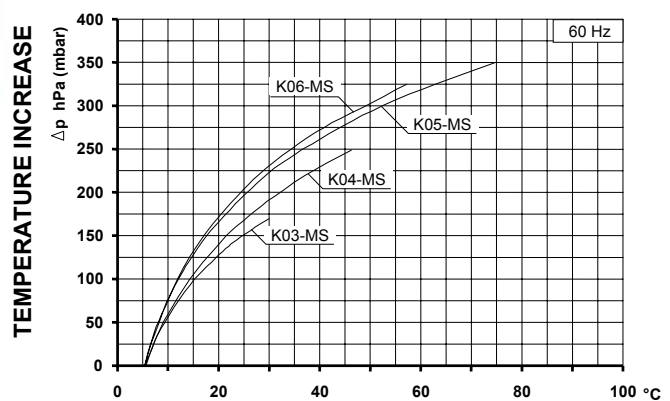
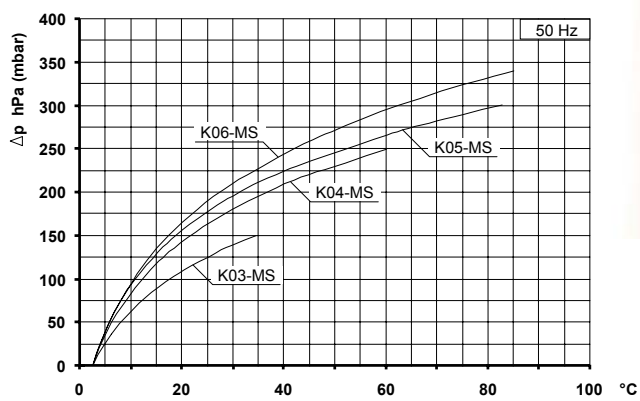
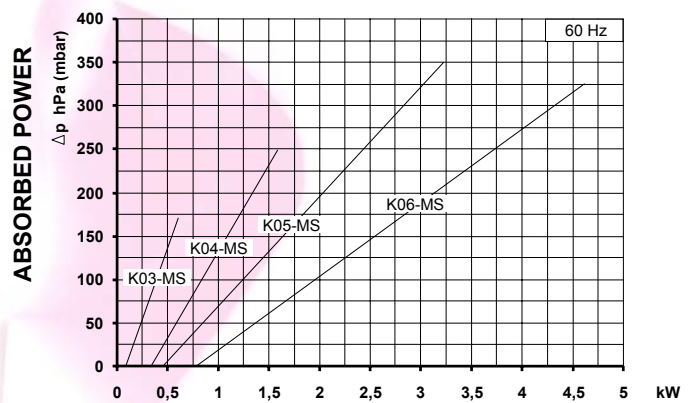
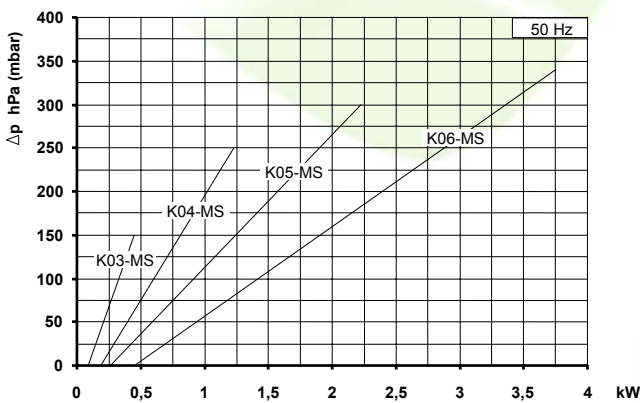
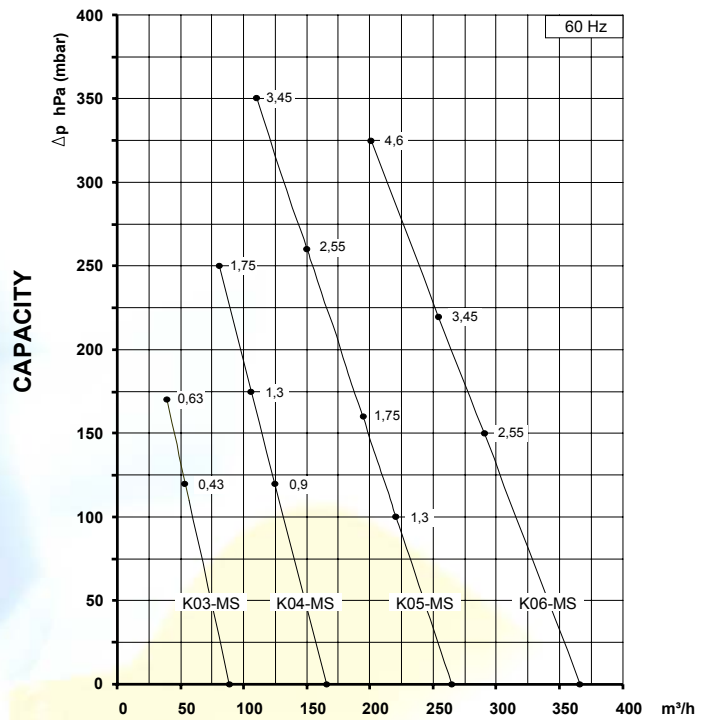
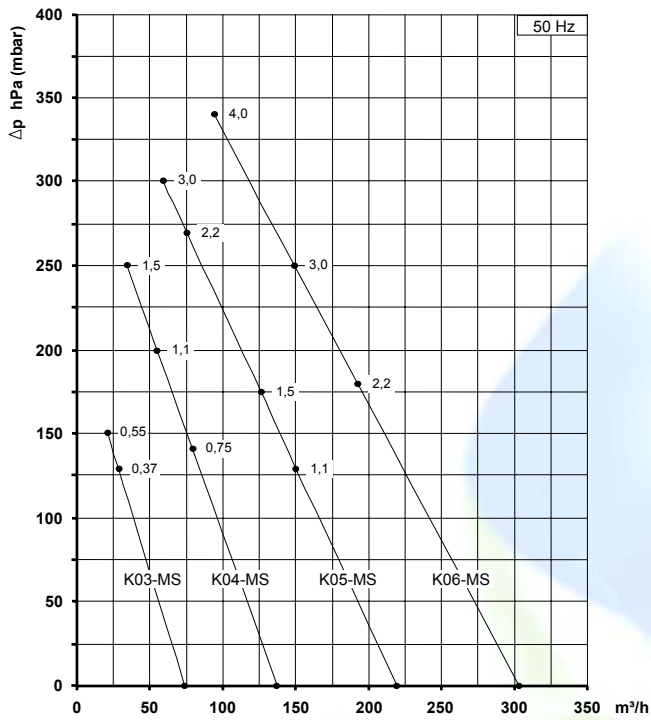

Curves refer to air at 20°C temperature and 1013 mbar (abs) atmospheric pressure measured at inlet port.  
 Values for flow, power consumption and temperature rise: +/-10% tolerance.  
 Data can change without prior notice.