



TECHNICAL CHARACTERISTICS

- Aluminium alloy construction
- Smooth operation
- High efficiency impeller
- Maintenance free
- Mountable in any position

OPTIONS

- Special voltages (IEC 38)
- Surface treatments

Possible alternative positions,
 please refer to drw SI 1854

Dimensions in mm.
 Dimensions for reference only

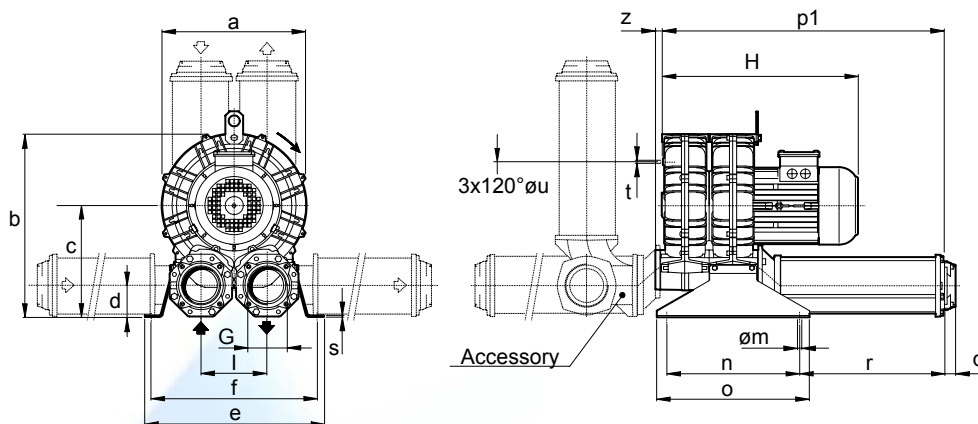

Model	a	b	c	d	e	f	G	l	m	n	o	p1	q	r	s	t	u	z
K03-TS	241	268	147	43	230	205	G 1" 1/4	86	10	83	142	280	18	75	4	M6	140	12
K04-TS	285	315	172	49	255	225	G 1" 1/2	102	12	95	171	315	18	70	4	M6	175	18
K05-TS	327	422	258	77	404	374	G 3"	150	13	300	345	634	25	328	4	M8	200	19
K06-TS	376	450	262	75	404	374	G 3"	155	13	300	345	662	25	335	4	M8	240	19

Model	Maximum flow m ³ /h		Installed power kW		Maximum differential pressure Δp hPa (mbar)		Noise level Lp dB (A) (1)		Overall dimensions H mm	Weight Kg
	50 Hz 2900 rpm	60 Hz 3500 rpm	50 Hz 2900 rpm	60 Hz 3500 rpm	50 Hz 2900 rpm	60 Hz 3500 rpm	50 Hz 2900 rpm	60 Hz 3500 rpm		
	K03-TS	131	158	0.75	0.9	100	90	67.5	69.5	375
			1.1	1.3	150	150	69.0	71.0	375	18.7
K04-TS	183	220	1.5	1.75	120	90	71.0	73.0	404	25.5
			2.2	2.55	200	160	72.5	74.5	404	28.5
K05-TS	409	493	2.2	2.55	115	90	70.0	72.0	440	40.5
			3.0	3.45	175	140	71.5	73.5	485	44.5
			4.0	4.6	250	210	73.5	75.5	485	48.0
K06-TS	563	679	4.0	4.6	130	100	75.2	77.2	490	56.0
			5.5	6.3	200	175	75.5	77.5	580	66.5
			7.5	8.7	300	275	75.8	77.8	580	71.5

(1) Noise measured at 1 m distance with inlet and outlet ports piped, in accordance to ISO 3744.

- For proper use, the blower should be equipped with inlet filter and safety valve; other accessories available on request.
- Ambient temperature from -15° to +40°C.
- Specifications subject to change without notice.

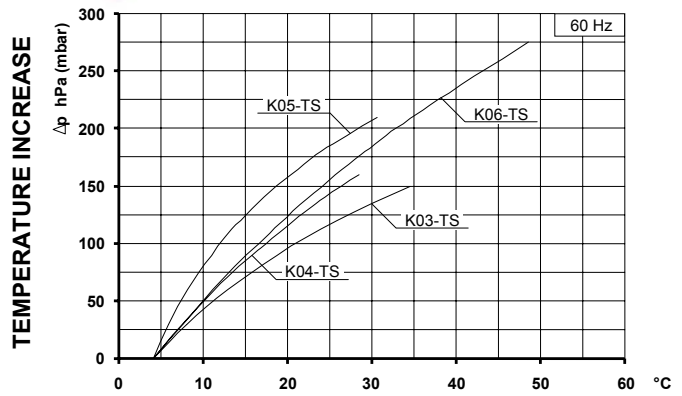
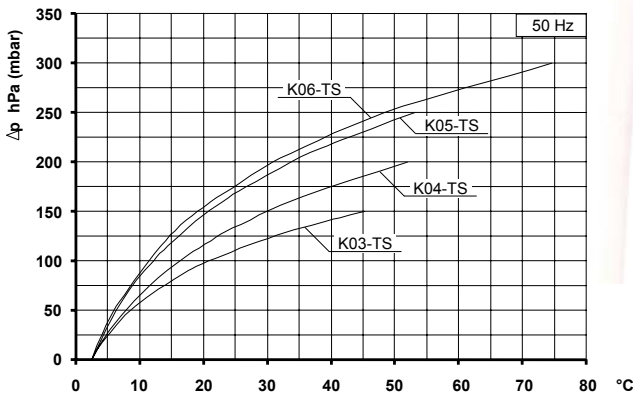
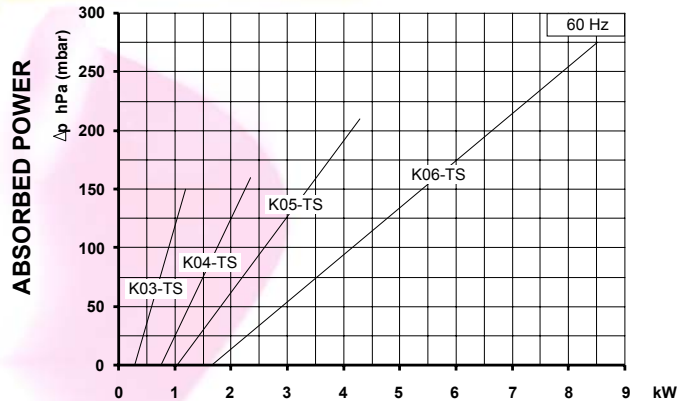
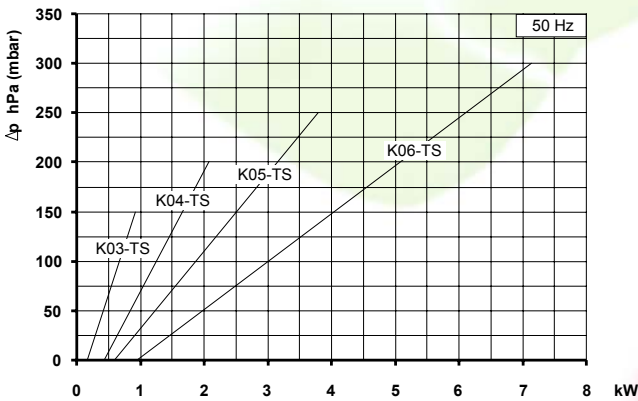
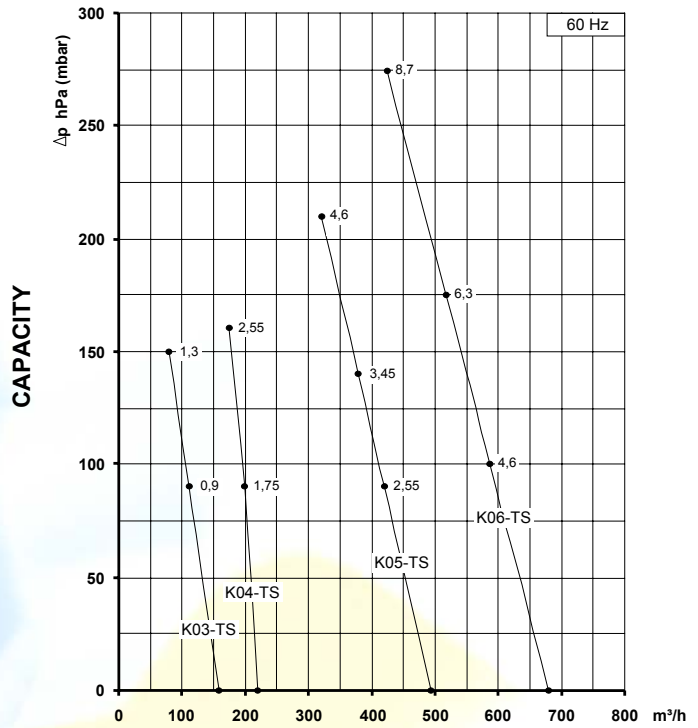
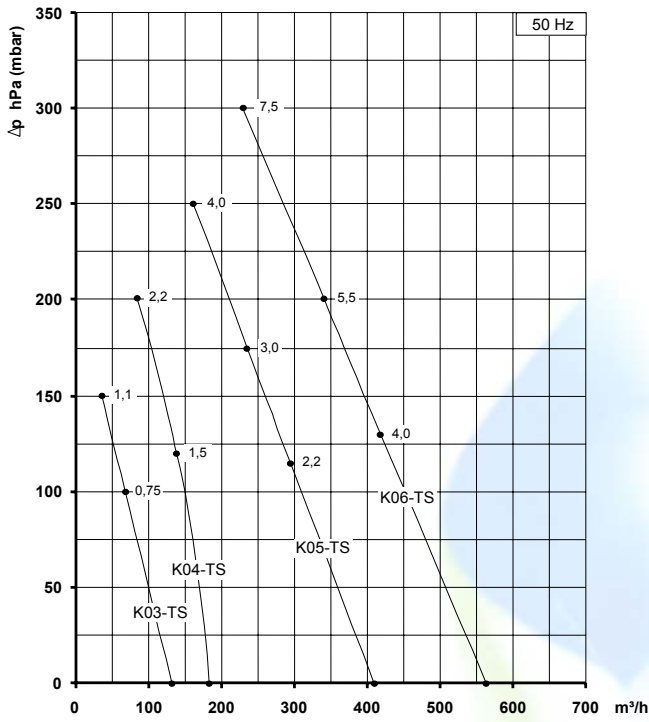

Curves refer to air at 20°C temperature and 1013 mbar (abs) atmospheric pressure measured at inlet port.
 Values for flow, power consumption and temperature rise: +/-10% tolerance.
 Data subject to change without notice.