



TECHNICAL CHARACTERISTICS

- Aluminium alloy construction
- Smooth operation
- High efficiency impeller
- Maintenance free
- Mountable in any position
- G1/8" female thread on both suction and discharge silencer port flanges.

OPTIONS

- Special voltages (IEC 38)
- Surface treatments

Possible alternative positions, please refer to drw SI 1822

Dimensions in mm.
Dimensions for reference only

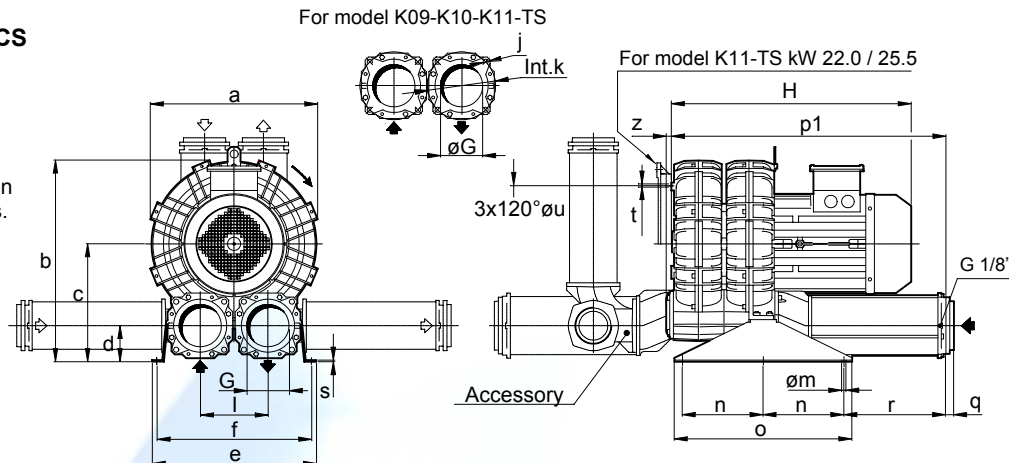

Model	a	b	c	d	e	f	G	l	j	k	m	n	o	p1	q	r	s	t	u	z
K07-TS	424	531	319	98	468	438	G 4"	182	-	-	13	250	550	802	25	299	5	M8	295	16
K08-TS	457	548	319	98	478	448	G 4"	182	-	-	13	250	550	802	25	299	5	M8	310	16
K09-TS	492	610	365	112	508	478	130	210	M16	210	13	250	550	850	-	315	5	M8	360	16
K10-TS	516	623	365	112	508	478	130	210	M16	210	13	250	550	850	-	315	5	M8	360	16
K11-TS	542	650	380	106	540	510	130	228	M16	210	13	250	550	870	-	320	5	M8	390	16

Model	Maximum flow m ³ /h		Installed power kW		Maximum differential pressure Δp hPa (mbar)		Noise level Lp dB (A) (1)		Overall dimensions H mm	Weight Kg
	50 Hz 2900 rpm	60 Hz 3500 rpm	50 Hz 2900 rpm	60 Hz 3500 rpm	50 Hz 2900 rpm	60 Hz 3500 rpm	50 Hz 2900 rpm	60 Hz 3500 rpm		
K07-TS	827	998	5.5	6.3	150	110	81.9	83.9	585	88.0
			7.5	8.7	225	200	82.2	84.2	620	93.0
			9.2	10.6	275	250	82.5	84.5	620	102.5
			11.0	12.7	350	300	82.8	84.8	620	103.5
			-	17.4	-	450	-	85.1	620	109.5
K08-TS	1007	1215	5.5	6.3	100	60	78.8	80.8	585	91.5
			7.5	8.7	160	120	78.9	80.9	620	96.5
			9.2	10.6	210	170	80.1	82.1	620	106.0
			11.0	12.7	260	220	81.3	83.3	620	107.0
			15.0	17.4	380	325	82.5	84.5	620	113.0
K09-TS	1325	1600	9.2	10.6	145	110	79.0	81.0	650	116.0
			11.0	12.7	190	150	81.0	83.0	650	117.0
			15.0	17.4	270	240	83.0	85.0	650	128.0
			18.5	21.5	360	275	85.0	87.0	745	158.0
K10-TS	1539	1858	11.0	12.7	160	125	85.8	87.8	650	122.0
			15.0	17.4	225	180	86.1	88.1	650	133.0
			18.5	21.5	275	260	86.4	88.4	745	163.0
K11-TS	1765	2130	11.0	-	100	-	86.0	-	665	135.0
			15.0	17.4	160	105	86.7	88.7	665	146.0
			18.5	21.5	220	165	87.4	89.4	760	176.0
			22.0 ⁽²⁾	25.5 ⁽²⁾	275	220	88.0	90.0	800	186.5

(1) Noise measured at 1 m distance with inlet and outlet ports piped, in accordance to ISO 3744.

(2) K11-TS kW 22.0 50 Hz / 25.5 60 Hz vertical assembly only.

- For proper use, the blower should be equipped with inlet filter and safety valve; other accessories available on request.
- Ambient temperature from -15° to +40°C.
- Specifications subject to change without notice.

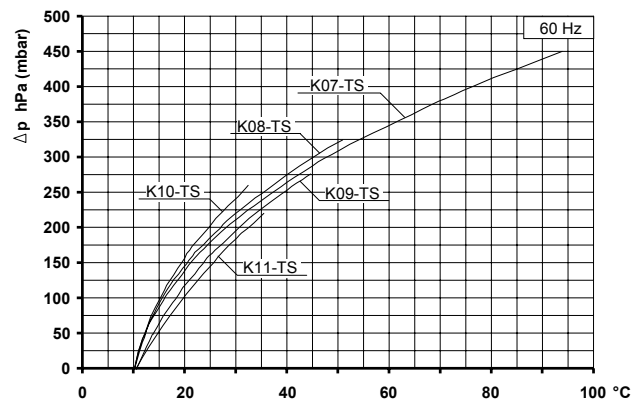
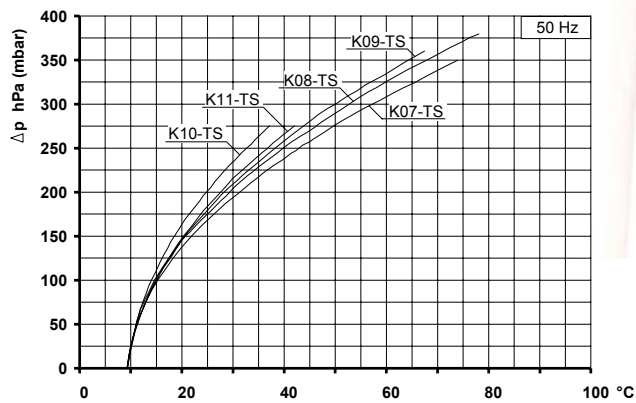
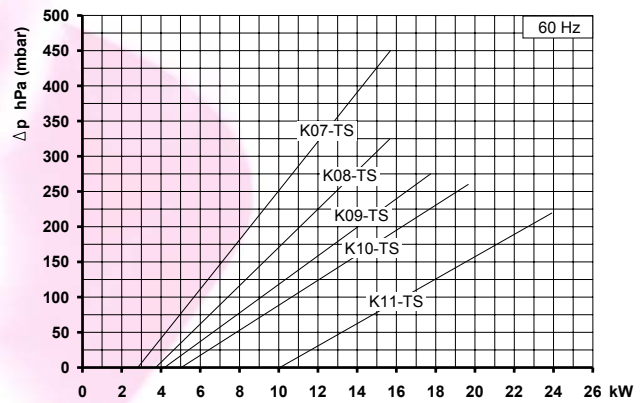
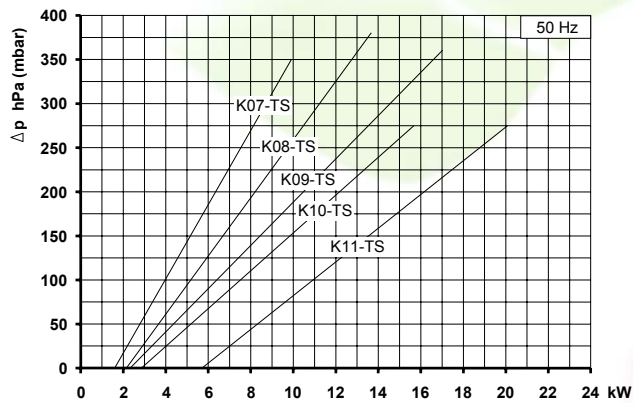
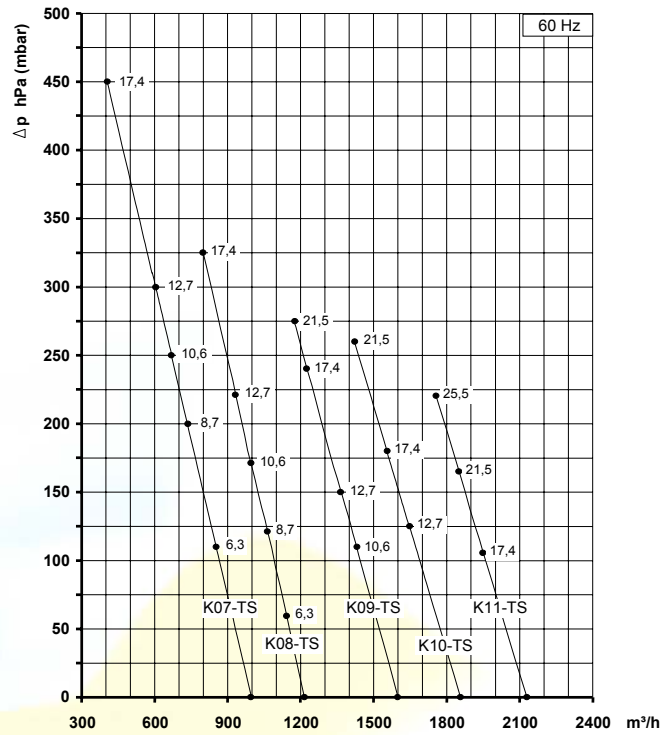
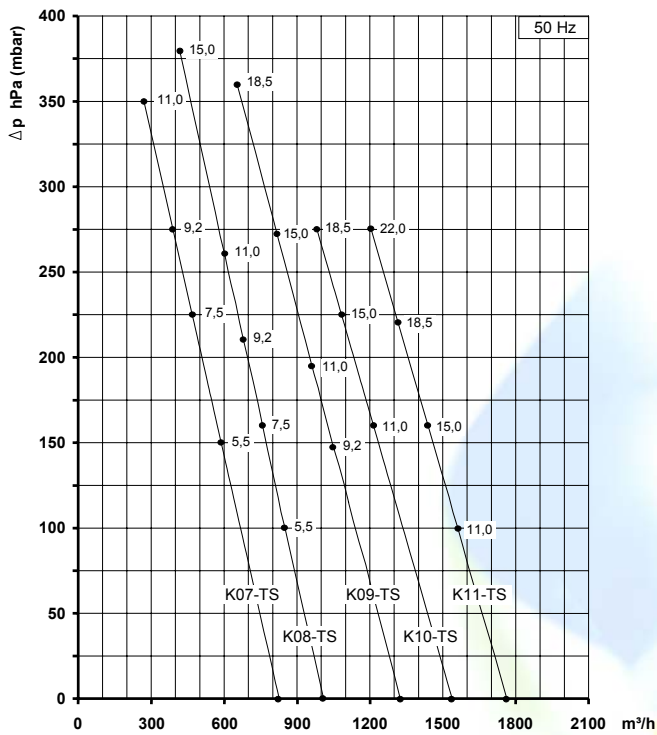

Curves refer to air at 20°C temperature and 1013 mbar (abs) atmospheric pressure measured at inlet port.
 Values for flow, power consumption and temperature rise: +/-10% tolerance.
 Data can change without prior notice.