

SP10 SERIES SELF-PRIMING PUMPS

ASSEMBLY, INSTALLATION AND OPERATION MANUAL

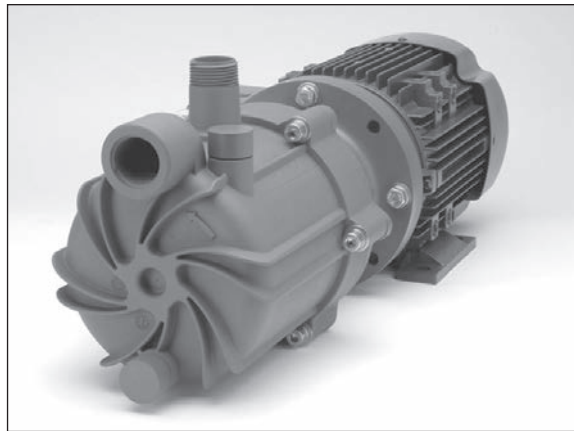

TABLE OF CONTENTS

Model Number/Serial Number	3
Important Notice	3
Chemical Reaction Disclaimer	3
Safety Precautions	3-4
SP10 Capabilities	4-5
Section I - Assembly	5-6
Section II - Installation	6-8
Motor/Electrical	8
Section III - Start-up and Operation	8
Section IV - Shutdown	8
Maintenance	9
Section V - Disassembly	9-12
Outer Drive Replacement	13
Thrust Ring Replacement	12
Bushing Replacement	12
Impeller Replacement	12
Section VI - Reassembly	12-13
Section VII - Troubleshooting	14
Section VIII - Warranty	14
Section IX - Spare Parts	15
Part Number Explanation	15
Alternate Components	15
Spare Parts Diagram	16
Spare Parts List	17-20



NOTE: Maintenance videos are now available online at www.finishthompson.com.

FTI Contacts:

Tech Service: 800-888-3743 or techservice@finishthompson.com
Order Fax: 814-459-3460 or 814-455-8518
Sales: 814-455-4478; 800-934-9384 (toll free U.S. & Canada)

Model Number and Serial Number

Record the model number and serial number below for future reference. This is important information when ordering replacement parts or when technical assistance is required. The numbers are found on a label located on the motor adapter.

MODEL NUMBER = _____

SERIAL NUMBER = _____

IMPORTANT NOTICE

U.S. Export Administration Regulations, pursuant to ECCN 2B350, prohibit the export or reexport to certain enumerated countries of sealless centrifugal pumps in which all wetted materials are constructed from fluoropolymers without first applying for and obtaining a license from the U.S. Bureau of Industry and Security (BIS). This affects all Finish Thompson magnetic-drive pumps constructed from PVDF or lined with ETFE. Please contact the BIS (www.bis.doc.gov) or Finish Thompson with questions regarding the Regulations or a list of the countries to which they apply.

Chemical Reaction Disclaimer

The user must exercise primary responsibility in selecting the product's materials of construction, which are compatible with the fluid(s) that come(s) in contact with the product. The user may consult Finish Thompson Inc. (manufacturer) and a manufacturer's representative/distributor agent to seek a recommendation of the product's material of construction that offers the optimum available chemical compatibility.

However neither manufacturer nor agent shall be liable for product damage or failure, injuries, or any other damage or loss arising out of a reaction, interaction or any chemical effect that occurs between the materials of the product's construction and fluids that come into contact with the product's components.

Safety Precautions

▲ WARNING: READ THIS MANUAL COMPLETELY BEFORE INSTALLING AND OPERATING THIS UNIT. FAILURE TO FOLLOW THESE PRECAUTIONS CAN RESULT IN SERIOUS INJURY OR DEATH.

▲ WARNING: Magnetic field hazard. This pump contains powerful magnets. Exposed magnets (pump not connected to motor) produce powerful magnetic fields. Individuals with cardiac pacemakers, implanted defibrillators, other electronic medical devices, metallic prosthetic heart valves, internal wound clips (from surgery), metallic prosthetic devices or sickle cell anemia must not handle or be in the proximity of the magnets contained inside the pump. Consult a health care provider for specific recommendations before working with this pump.

▲ WARNING: Magnetic force hazard. This pump should only be disassembled and assembled using the recommended procedures. The magnetic attraction is powerful enough to rapidly pull the motor end and the wet end together. Do not place fingers between the mating surfaces of the motor and wet ends to avoid injuries. Keep the drive magnet and impeller assembly away from metal chips or particles, items with magnetic stripes like credit cards, and magnetic computer media such as floppy discs and hard drives.

▲ WARNING: Not Recommended for Pumping Flammable or Combustible Liquids. During the priming process the internal pump atmosphere can become very dangerous should the pump fail to prime and overheat.

The SP Series pumps can be used to pump non-flammable or non-combustible liquids in a hazardous area. It is important to follow these guidelines:

1. Select the Ns (non-sparking) bronze bump ring option. The non-sparking ring is pressed into the clamp ring or motor adapter and prevents sparking should the motor bearings fail and the outer mag drive assembly runs out of round.
2. Select an FTI explosionproof motor or provide your own.

▲ WARNING: Hot surfaces. This pump is capable of handling liquids with temperatures as high as 220° F (104° C). This may cause the outer areas of the pump to become hot as well and could cause burns.

▲ WARNING: Rotating Parts. This pump has components that rotate while in operation. Follow local safety standards for locking out the motor from the power supply during maintenance or service.

▲ WARNING: Chemical Hazard. This pump is used for transferring many types of potentially dangerous chemicals. Always wear protective clothing and eye protection, and follow standard safety procedures when handling corrosive or personally harmful materials. Proper procedures should be followed for draining and decontaminating the pump before disassembly and inspection of the pump. There may be small quantities of chemicals present during inspection.

▲ WARNING: Never run pump at less than minimum flow or with the discharge valve closed. This could lead to pump failure.

⚠ WARNING: The pump and associated components are heavy. Failure to properly support the pump during lifting and movement could result in serious injury or damage to the pump and components.

⚠ CAUTION: This pump should never be started without the 0.6 US gallon /77 oz. (2.7 liters) of priming fluid in the housing. If the pump has a PTFE, ceramic or silicon carbide bushing, **IT CANNOT BE RUN DRY WITHOUT CAUSING DAMAGE TO THE PUMP.** However, the pump can operate without liquid in the housing if the pump has a carbon bushing. The exact length of time the pump can operate dry with a carbon bushing varies with operating conditions and environment.

⚠ CAUTION: Never start or operate with a closed suction valve.

⚠ WARNING: Operation without priming or against a closed discharge valve can result in high temperatures that can result in injury or damage to pump components.

⚠ CAUTION: Always provide adequate NPSHa (net positive suction head available). It is recommended to provide at least 2 feet (61 cm) above the NPSHr (net positive suction head required).

⚠ CAUTION: If pump is used on variable speed drive, do not exceed 60 Hz.

SP10 Capabilities

Maximum Working Pressure: 80 psi (5.5 bar)

Maximum Temperature: Polypropylene: 180° F (82° C); PVDF: 220° F (104° C)

NOTE: Maximum temperature is application dependent. Consult a chemical resistance guide or the chemical manufacturer for chemical compatibility and temperature limits.

Maximum Lift: 25 feet (7.6 meters) with 4.18" and 4" diameter impellers. See the chart below for maximum lift for other impeller diameters.

SP10 Maximum Lift Chart				
Impeller Diameter	1" (25.4 mm) Suction Piping		1.5" (38.1 mm) Suction Piping	
	Max. Lift @ 3450 rpm	Max. Lift @ 2900 rpm	Max. Lift @ 3450 rpm	Max. Lift @ 2900 rpm
4.18" (106.2 mm)	25' (7.6 M)	25' (7.6 M)	25' (7.6 M)	25' (7.6 M)
4.00" (101.6 mm)	25' (7.6 M)	25' (7.6 M)	25' (7.6 M)	20' (6.1 M)
3.75" (95.3 mm)	20' (6.1 M)	20' (6.1 M)	20' (6.1 M)	15' (4.6 M)
3.5" (88.9 mm)	20' (6.1 M)	15' (4.6 M)	15' (4.6 M)	10' (3.1 M)
3.25" (82.6 mm)	15' (4.6 M)	10' (3.1 M)	15' (4.6 M)	10' (3.1 M)
3" (76.2 mm)	10' (3.1 M)	5' (1.5 M)	10' (3.1 M)	5' (1.5 M)

NOTE: Lift was determined on fresh, cold water with 1" and 1 1/2" Schedule 40 pipe. Specific gravity affects lift capability. Divide maximum lift from chart above by the specific gravity to determine equivalent maximum lift.

Solids: Maximum particle size is 100 microns for slurries and 1/64" (.4 mm) for infrequent particles. Maximum hardness is 80 HS. Maximum concentration is 10% by weight. If solids are being pumped, it is recommended the pump has either ceramic or, for best results, silicon carbide components. Pumping solids may lead to increased wear.

NOTE: While the pump is capable of being used in sump applications, it is NOT a trash pump. Care must be taken to ensure that debris and foreign objects do not enter the pump or damage may result. Suggest using a 1" strainer basket with 1/32" (.8 mm) perforations or 1 1/2" strainer basket with 1/8" (3.2 mm) perforations. Regular strainer basket maintenance is required to prevent plugging and decrease in NPSHa so not to starve and damage the pump.

Minimum Allowable Flow Rate

Do not allow the flow rate to drop below the minimum flow rate listed in the chart below.

Model	3450 rpm	2900 rpm
SP10	1/2 gpm (1.9 lpm)	1.9 lpm (1/2 gpm)

Maximum Sound Level:

69 dBA (pump only)

Maximum Allowable Motor Power

- Do not exceed the maximum power rating for the pump coupling.
- Standard coupling for the SP10 is 10-pole & maximum 2 HP (1.5 kW).

Priming Liquid Volume

Initial filling (or refilling after maintenance) of the pump housing requires 0.6 US gallon / 77 oz. (2.7 liters) of liquid.

Unpacking and Inspection

Unpack the pump and examine for any signs of shipping damage. If damage is detected, save the packaging and notify the carrier immediately.

SP10 Assembly, Installation and Operation

Section I - Assembly

Tools Required:

Metric socket or wrench set, 9/16" socket or wrench, 8 mm Allen wrench, and 3/16" Allen wrench (NEMA motors only) and pliers (for fill/drain plugs).

Pumps with Motors

Proceed to "Installation" Section II.

Pumps Without Motors



1. Remove the pump, drive magnet assembly and hardware package from the carton.

CAUTION: Keep away from metallic particles, tools and electronics. Drive magnets **MUST** be free of metal chips.

WARNING: Keep the drive magnet away from the open end of the motor adapter and barrier. Strong magnetic attraction could allow the drive hub to enter the motor adapter resulting in injury or damage.

2. Place motor on the fan end. See figure 1.

NOTE: For 56C/145TC frame motors go to step 4.



Figure 1

3. For Metric motors install the motor adapter flange (item18) on the motor face using bolts, lock washers and flat washers (items 31,32 & 33). See figure 2.

Torque bolts to the following:

- 63 frame (M4) = 30 in-lb (3.4 N-m)
- 71 frame (M5) = 90 in-lb (10.2 N-m)
- 80 frame (M6) = 90 in-lb (10.2 N-m)

NOTE: 63/71 B14 adapter flange is reversible. Install 63/71 B14 adapter so that proper motor flange size is facing motor.

NOTE: Apply anti-seize compound on the threads of the bolts.

4. Coat the motor shaft with anti-seize compound. Insert the key supplied with the motor into the keyway on the motor shaft. See figure 3.

Note: Make sure the motor shaft is clean & free of burrs. The outer drive is precision machined and has a bore tolerance of +.0005/-0 inch.



Figure 2



Figure 3

- Slide the outer drive magnet assembly (item 17) onto the motor shaft until the motor shaft contacts the snap ring in the bore of the drive. See figures 4 & 5.



Figure 4



Figure 5

- Secure the drive on the motor shaft.

⚠ WARNING: Be careful, magnets will try to attract tools.

Metric Motors: Secure the drive to the motor shaft using bolt, lock washer and flat washer (items 25, 26, 27). Thread the bolt into the end of the motor shaft (while holding the outer drive to prevent it from turning). See figure 6.

Tighten the bolt to the following:

- 63 frame (M4) = 15 in-lb (1.7 N-m)
- 71 frame (M5) = 30 in-lb (3.4 N-m)
- 80 frame (M6) = 90 in-lb (10.2 N-m)
- 90 frame (M8) = 130 in-lb (14.7 N-m)

NEMA Motors: Install (2) 3/8" set screws (item 17B) into threaded holes on the side of the outer drive magnet assembly. Using a 3/16" Allen wrench, tighten to 228 in-lbs (25.8 N-m). See figure 7.

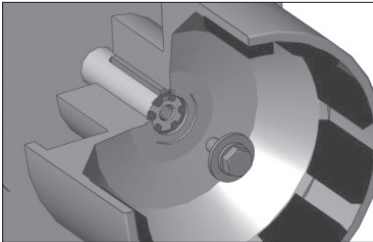

Figure 6

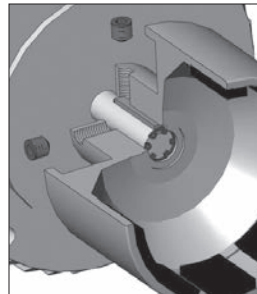

Figure 7

- Install the pump end on the motor/drive magnet assembly. With the motor/outer drive magnet assembly in a horizontal position, securely clamp to the workbench.

NOTE: If the pump has the optional o-ring sealing option (available on 56C and 145TC frame pumps only), install the o-ring (item 16) in the groove in the motor adapter (motor end).

Carefully slide the pump onto the drive magnet assembly. The last couple of inches (5 cm) before the pump reaches the motor will have **STRONG** magnetic attraction between the pump and outer drive magnet

assembly.

- Secure the pump to the motor with (4) 3/8" bolts, lock washers and flat washers (items 28, 29 & 30) using a 9/16" socket or wrench. Tighten to 240 in-lb (27.1 N-m). See figures 8 and 9.

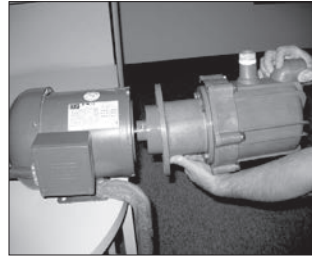

Figure 8



Figure 9

- Rotate the motor fan to ensure that there is no binding in the pump.
- Proceed to Installation Section

Section II - Installation

Mounting

Motor feet should be securely fastened to a solid foundation.

Note: Shims are required for the motor feet on ALL 63, 71 and 80 frame motors and 90 frame B5 motors.

Piping

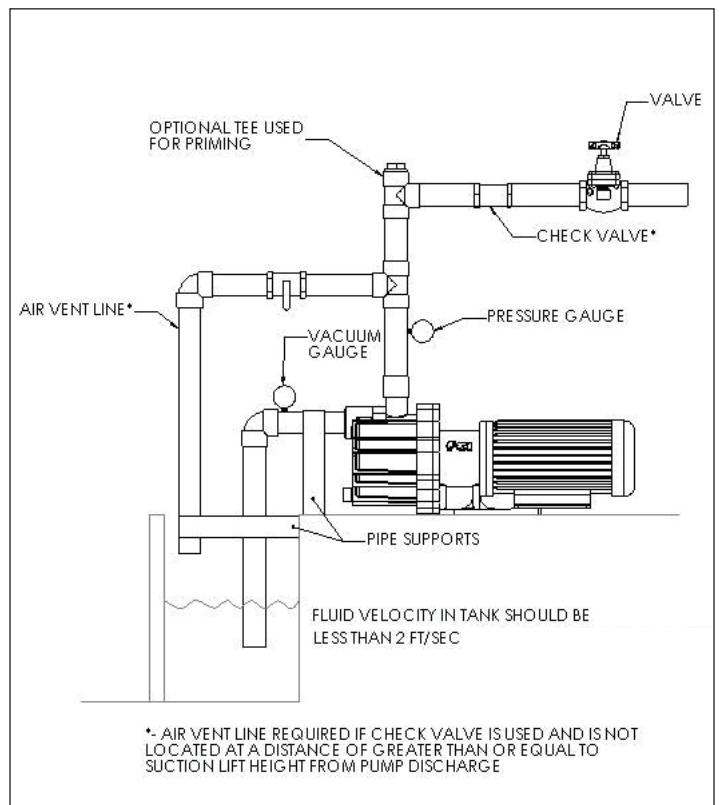

⚠ CAUTION: The NPSH available to the pump must be greater than the NPSH required. The amount of lift, frictional pipe loss, and vapor pressure must be calculated into the application. NPSH available should be 2 feet (.6 meters) greater than NPSH required.

- Total suction lift including pipe friction loss and corrections for specific gravity must not exceed value shown in chart below.

SP10 Maximum Lift Chart				
Impeller Diameter	1" (25.4 mm) Suction Piping		1.5" (38.1 mm) Suction Piping	
	Max. Lift @ 3450 rpm	Max. Lift @ 2900 rpm	Max. Lift @ 3450 rpm	Max. Lift @ 2900 rpm
4.18" (106.2 mm)	25' (7.6 M)	25' (7.6 M)	25' (7.6 M)	25' (7.6 M)
4.00" (101.6 mm)	25' (7.6 M)	25' (7.6 M)	25' (7.6 M)	20' (6.1 M)
3.75" (95.3 mm)	20' (6.1 M)	20' (6.1 M)	20' (6.1 M)	15' (4.6 M)
3.5" (88.9 mm)	20' (6.1 M)	15' (4.6 M)	15' (4.6 M)	10' (3.1 M)
3.25" (82.6 mm)	15' (4.6 M)	10' (3.1 M)	15' (4.6 M)	10' (3.1 M)
3" (76.2 mm)	10' (3.1 M)	5' (1.5 M)	10' (3.1 M)	5' (1.5 M)

NOTE Maximum suction lift is reduced by 1.13 feet (.34 meters) for every 1,000 feet (304 meters) of altitude.

- Install the pump as close to the suction source as possible.
- SP Series pumps are designed to operate in a horizontal position only with discharge on the top.
- SP Series pumps self-priming capability is due to its ability to create a vacuum in the suction piping. The suction piping **MUST** be airtight at fittings and connections.
- Support the piping independently near the pump to eliminate any strain on the pump casing. In addition, the piping should be aligned to avoid placing stress on the pump casing.
- The suction side of the pump should be as straight and short as possible to minimize pipe friction.
- The suction line should not have any high spots. This can create air pockets that can reduce pump performance. The suction piping should be level or slope slightly upward to the pump.
- The suction pipe should be 1" (25.4 mm) or 1½" (38 mm). Larger suction piping will affect priming ability. Smaller piping affects NPSH available and pump performance. See SP10 performance curve book or on-line at www.finishthompson.com.
- Provide for adequate suction submergence. Excessive submergence will reduce pump performance.

- The end of the pipe should be at least 2" (5.08 cm) for 1" pipe & 3" (7.6 cm) for 1½" pipe above the bottom of the suction tank.
- If debris is in the suction tank, a strainer can be installed to help prevent foreign matter from entering the pump. The strainer must be periodically cleaned to prevent restriction.
- It is recommended that a vacuum/pressure gage be installed in the suction piping.
- For faster priming on installations with high lift, a foot valve is recommended.
- Check and control valves (if used) should be installed on the discharge line. The control valve is used for regulating flow. Isolation valves on the suction and discharge are used to make the pump accessible for maintenance. The check valve helps protect the pump against damage from water hammer. This is particularly important when the static discharge head is high.

NOTE: If a check valve is used in the discharge line, it must be placed at a distance at least equal to the maximum suction lift from the pump. If this cannot be done, an air vent must be provided in the discharge line.

- If flexible hose is preferred over pipe, use a vacuum rated reinforced hose for the proper temperature, pressure and is chemically resistant against the fluid being pumped.
 - The suction valve must be completely open to avoid restricting the suction flow.
 - When installing pumps with flanges, we recommend use of low seating stress gaskets such as Gore-Tex or Gylon (expanded PTFE).
 - It is advisable to install a flush system in the piping to allow the pump to be flushed before the pump is removed from service.
- NOTE:** The pump is provided with a 1/2" BSPP drain in the impeller housing.
- A "tee" can be installed in the discharge piping as an alternative location for filling the housing with fluid before pump operation.
 - "Filling" is defined as filling the housing with 0.6 US gallon / 77 oz. (2.7 liters) of liquid
 - "Priming" is defined as evacuating all the air from the suction piping/pump and replacing it with fluid. See Priming chart on next page.

SP10 Priming Time Chart																				
Impeller Diameter		1" (25.4 mm) Suction Piping										1.5" (38.1 mm) Suction Piping								
		Motor Speed										Motor Speed								
		3450 RPM					2900 RPM					3450 RPM					2900 RPM			
		Feet of Lift (sec.)					Meters of Lift (sec.)					Feet of Lift (sec.)					Meters of Lift (sec.)			
in. (mm)	5	10	15	20	25	1.5	3.1	4.6	6.1	7.6	5	10	15	20	25	1.5	3.1	4.6	6.1	7.6
4.18 (106.2)	10	35	65	100	140	10	40	80	160	240	25	60	100	150	210	30	75	145	255	455
4.00 (101.6)	12	37	68	130	310	20	50	90	200	320	28	60	100	180	280	35	80	150	360	
3.75 (95.3)	15	45	72	155		30	45	135			30	70	110	275		40	95	240		
3.5 (88.9)	20	50	75	185		35	75	225			35	80	150			60	120			
3.25 (82.6)	25	60	145			37	150				40	88	240			85	225			
3 (76.2)	27	115				60					55	165				120				

NOTE: Times shown are guidelines only. Times will vary based on system and piping setups.

Motor/Electrical

Install the motor according to NEC requirements and local electrical codes. The motor should have an overload protection circuit.

Wire the motor for clockwise rotation when facing the fan end of the motor.

⚠ CAUTION: Do not operate the pump to check rotation until the pump is full of liquid.

Check all electrical connections with the wiring diagram on the motor. Make sure the voltage, frequency, phase, and amp draw comply with the supply circuit.

To verify correct rotation of the motor:

1. Install the pump into the system.
2. Remove the fill plug (items 2 & 2A) and fill the housing with 0.6 US gallon / 77 oz. (2.7 liters) of the service liquid or water. Replace fill plug and tighten until the o-ring is seated.
NOTE: Use a flexible spout funnel or a "tee" in the discharge piping to fill the housing on pumps equipped with flanges.
3. Fully open the suction and discharge valves.
4. Jog the motor (allow it to run for 1-2 seconds) and observe the rotation of the motor fan. Refer to the directional arrow molded into the front of the housing if necessary.

NOTE: An SP pump running backwards may not prime.

Section III - Start-up and Operation

1. Be sure the housing (item 1) has been filled with 0.6 US gallon / 77 oz. (2.7 liters) of service liquid and the fill plug (item 2 & 2A) has been installed and tightened until the o-ring is seated.

2. Open the inlet (suction) and outlet (discharge) valves completely.
3. Turn the pump on. Wait for discharge pressure and flow to stabilize (could take several minutes depending upon suction lift). Adjust the flow rate and pressure by regulating the discharge valve. Do not attempt to adjust the flow with the suction valve.

Section IV - Shutdown

Turn off the motor.

NOTE: When the pump is stopped without a check valve in the piping, liquid will flow through the pump returning to the suction source. The SP design allows enough liquid to be retained in the housing to allow repriming without having to refill with liquid.

Flush Systems

CAUTION: Some fluids react with water; use compatible flushing fluid.

1. Turn off the pump.
- ⚠** Completely close the suction and discharge valves.
3. Connect flushing fluid supply to flush inlet valve.
4. Connect flushing fluid drain to flush drain valve.
5. Open flushing inlet and outlet valves. Flush system until the pump is clean.

NOTE: The drain can be used as the flushing drain valve using appropriate customer supplied fittings. Using the drain helps to promote superior flushing and draining results.

Maintenance

Recommended maintenance schedule

The recommended maintenance schedule depends upon the nature of the fluid being pumped and the specific application. If the pump is used on a clean fluid, it is recommended that the pump be removed from service and examined after six months of operation or after 2,000 hours of operation.

If the pump is used on fluids with solids, high temperatures or other items that could cause accelerated wear, this initial examination should be sooner.

After the initial examination of the internal components and wear items are measured, a specific maintenance schedule can be determined. For best results, it is recommended that the pump be removed from service annually for examination.

Section V - Disassembly



Tools Required:

Metric socket or wrench set, 13mm socket or wrench, 3/16" Allen Wrench (NEMA motors only), pliers (for fill/drain plugs), and (2) Flat Head screwdrivers.

⚠ WARNING: Rotating Parts. This pump has components that rotate while in operation. Follow local safety standards for locking out the motor from the power supply during maintenance or service.

⚠ WARNING: Chemical Hazard. This pump is used for transferring many types of potentially dangerous chemicals. Always wear protective clothing, eye protection, and follow standard safety procedures when handling corrosive or personally harmful materials. Proper Procedures should be followed for draining and decontaminating the pump before disassembly and inspection of the pump. There may be small quantities of chemicals present during inspection.

⚠ WARNING: Magnetic force hazard. This pump should only be disassembled and assembled using the recommended procedures. The magnetic attraction is powerful enough to rapidly pull the motor end and the wet end together. Do not place fingers between the mating surfaces of the motor and wet ends to avoid injuries. Keep the drive magnet and impeller assembly away from metal chips or particles.

1. Stop the pump, lock out the motor starter, close all the valves that are connected to the pump, and drain/decontaminate the pump.

⚠ WARNING: The pump must be thoroughly flushed of any hazardous materials and all internal pressure relieved prior to opening the pump. Allow the pump to reach ambient temperatures prior to performing maintenance.

2. Securely clamp the motor to the bench. Remove the (4) 3/8" motor adapter bolts, lock washers and flat

washers (items 28, 29 & 30) securing the pump to the motor. See figure 10.

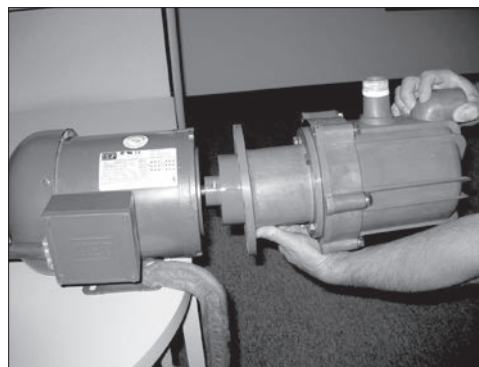

Figure 10

3. Firmly grab the pump and pull straight back to disengage the motor and pump.
4. Place pump on bench with housing (item 1) facing up. Using a 13mm socket or wrench, remove (6) 8M housing bolts, lock washers and flat washers (items 19, 20 & 21). See figure 11.



Figure 11

5. Remove the housing by carefully inserting two flat head screwdrivers at the locations shown in figure 12. Slide the screwdrivers in at the bolt holes between the metal clamp ring (item 13) and the housing until they stop. Applying equal pressure, gently pry both screwdrivers in an upward motion away from the work bench (to avoid damaging sealing surface on the housing). See figure 12A. Housing is tight due to o-ring seal on the internal "gooseneck." **NOTE:** Do not twist the screwdrivers or damage may occur to the housing. Lift the housing straight up to remove.

Insert one screwdriver under this bolting location. Insert approximately 3/4" (19 mm) until it hits the barrier.

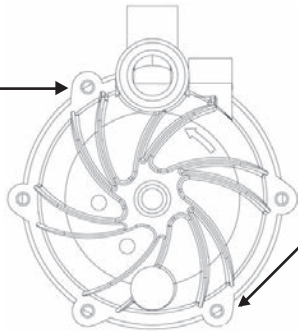

Figure 12

Insert one screwdriver under this bolting location. Insert approximately 3/4" (19 mm) until it hits the barrier.

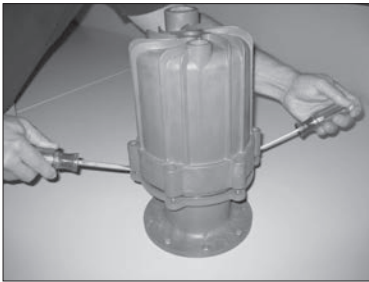

Figure 12A

6. Inspect housing for signs of wear or damage. Inspect "gooseneck" for cracks. Inspect suction and discharge for cracks. See figure 13. Inspect fill and drain plug o-rings (item 2 & 2A) for chemical attack, swelling, brittleness, cuts, etc.
7. Pull the separator plate (item 6) off the inner volute (item 7). See figure 14. Inspect for damage and cracks.

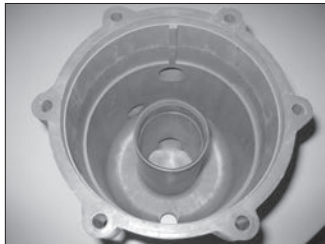

Figure 13



Figure 14

8. To remove the inner volute (item 7), pull back the (3) snap fit prongs one at a time so that the hook portion falls into the channel on the inner volute. See figures 15 & 16.

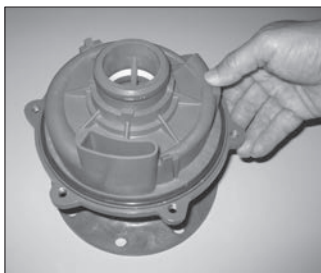

Figure 15

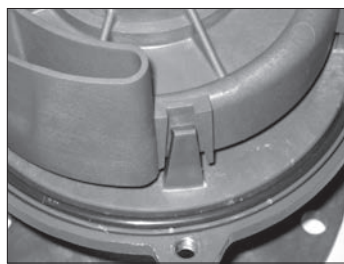

Figure 16

9. Pull the inner volute straight off. Be careful since the impeller shaft may come out with the inner volute. See figure 17.



Figure 17

10. Remove impeller/inner drive assembly (items 8, 8A, 9 & 9A). Inspect impeller and drive for signs of wear or damage. See figure 18. Check the impeller thrust ring and bushing for wear. See figure 19.

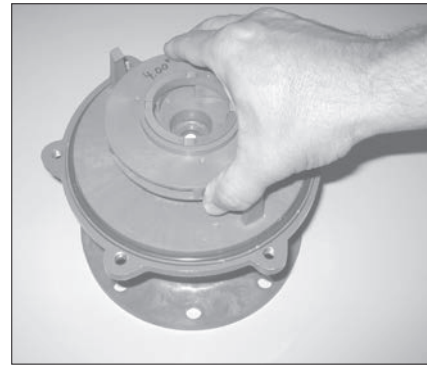

Figure 18

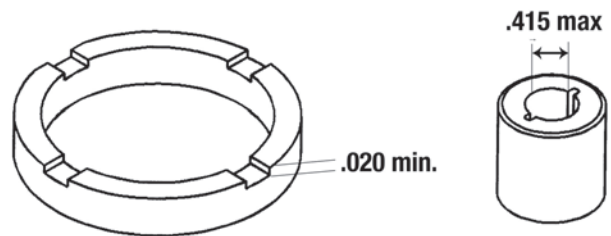

Figure 19

11. Remove the impeller shaft (item 10) from the barrier (item 11) and check for signs of cracking, chipping, scoring or wear. See figure 20.



Figure 20

- Pull on one of the 3 prongs to remove the barrier (item 11) from the clamp ring and motor adapter (items 13 & 15). NOTE: Prongs are sharp. Use a glove or rag for better grip. Motor adapters have an o-ring seal between the barrier and adaptor so fit may be snug. See figure 21. Inspect the inside and outside of the barrier for signs of rubbing.



Figure 21

- Remove the o-ring (item 4) from the barrier and inspect for chemical attack, swelling, brittleness, cuts, etc.
- Visually inspect the outer drive (item 17) for rubbing, damage, corrosion, or loose magnets.

Outer Drive Replacement

- Remove the setscrews (item 17B) from the side of the drive (NEMA motors) or the bolt, lock washer and flat washer (items 25, 26 & 27) from the center of the drive (metric motors).

WARNING: Be careful, tools will want to be attracted to the magnets.

- Remove the drive magnet from the motor shaft by gently prying up from the bottom of the drive. See figure 22.
- To reinstall the drive or a new drive, follow the instructions from Section I – Assembly, Pumps without Motors, Steps 4-6.



Figure 22

tions from Section I – Assembly, Pumps without Motors, Steps 4-6.

Thrust Ring Replacement

- The thrust ring (item 8A) is held in-place with a snap fit with a ridge. Using a razor, knife, or side cutters, cut a notch out of the thrust ring. Pull ring up and out of the holder. See figures 23 & 24.

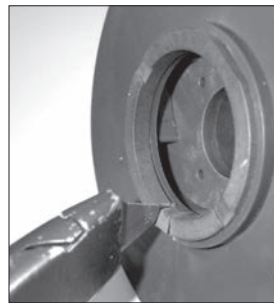

Figure 23

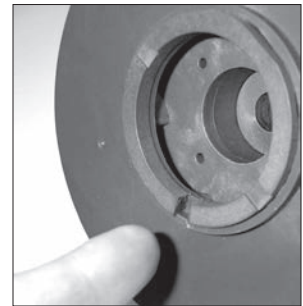

Figure 24

- To reinstall, align the two flats on the thrust ring with the flats in the bore of the impeller. Using a piece of wood, press into place using an arbor press until the thrust ring is completely seated in the impeller.



Bushing Replacement

To remove the bushing, place the impeller/inner drive assembly in an arbor press. Insert a 7/16" diameter plastic or wood shaft through the eye of the impeller and press the bushing out.

To replace the bushing (item 9A), place the top of the impeller on an arbor press with the thrust ring face down. Insert the front of the bushing (see figure 25) into the center of the impeller/inner drive magnet assembly. Press into place until the bushing reaches the shoulder molded into the inner drive. See figures 26 & 27.

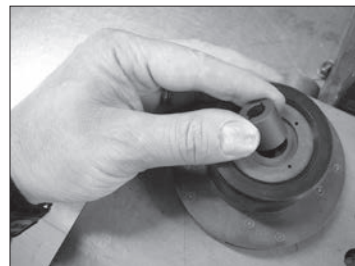

Figure 25



Figure 26

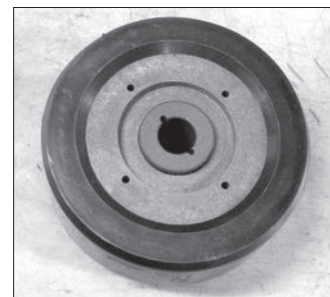

Figure 27

Impeller Replacement



To remove the impeller from the inner drive magnet, gently pry off by hand or lightly tap on the back of the impeller. See figure 28.

To install a new impeller, place the inner drive magnet assembly face up. Line up the patterns on the impeller with the ones on the inner drive magnet so

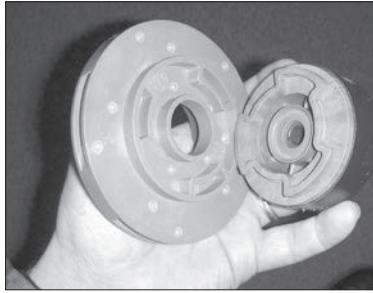

Figure 28

they match and press into place by hand. An arbor press can also be used to press the impeller on the inner drive. Place a piece of wood over the top of the impeller thrust ring and push down on the impeller until it is completely seated in the inner drive.

Section VI Reassembly

1. Place motor adapter (item 15) so the large flange is on the bench. Rotate the adapter so the four holes in the smaller flange are in the horizontal position. See figure 29. If removed, reinstall the o-ring (item 14) in the groove on the face of the motor adapter.

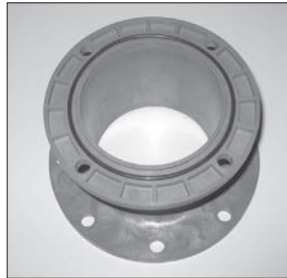

Figure 29

Lubricate the o-ring with chemically compatible lubricant. This will help to hold it in place. See figure 29.

2. Install clamp ring. Note: The discharge fitting must be in the vertical position for all SP series pumps to work properly – Install the clamp ring (item 13) on the motor adapter so NO clamp ring bolt holes are in 12:00 or 6:00 position (see figure 30). Align the (4) bolt holes with the bolt holes in the motor adapter & push straight down. This will properly seat the o-ring to prevent vapors from entering this area during pump operation.
3. Install (4) flat washers, lock washers and M8 bolts (items 22, 23, 24). Tighten evenly using a star pattern. Tighten to 60 in-lbs (6.8 N-m). See figure 31.



Figure 30



Figure 31

4. Install barrier into motor adapter/clamp ring assembly.
NOTE: If removed, reinstall the o-ring (item 12), lubricate with a chemically compatible lubricant, and install in the groove in the clamp ring before installing the barrier. See figure 33A. Lubricate the back of the barrier with a chemically compatible lubricant and push it straight down into place. See figure 33B. Note: Barrier can only be installed in one position. The barrier prongs should be placed in the 11:00, 2:00 and 5:00 o'clock positions. See figure 33 for correct orientation. Line up the 5:00 o'clock prong with the bottom bolt hole in the motor adapter. See figure 33C.



Figure 33A



Figure 33B

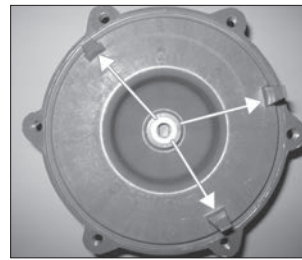

Figure 33

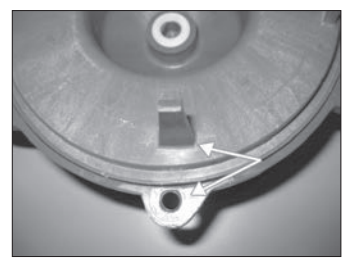

Figure 33C

5. Install o-ring (item 4) in groove in the barrier making sure it is tucked in all the way around.
6. Install impeller shaft (item 10) into barrier by aligning the flats on the shaft with the ones in the barrier. Make sure it is completely seated.
7. Carefully install the impeller/inner drive assembly (items 8, 8A, 9 & 9A) by sliding it over the impeller shaft in the barrier. It is normal for the impeller/inner drive to pop up a slight amount due to magnetic forces with the metal clamp ring. See figures 34 & 35.

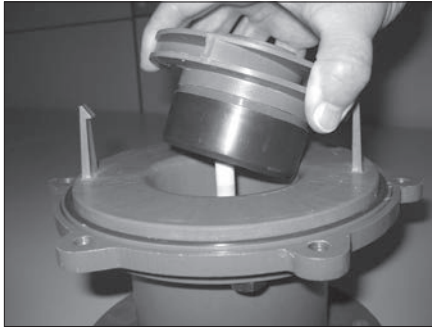

Figure 34

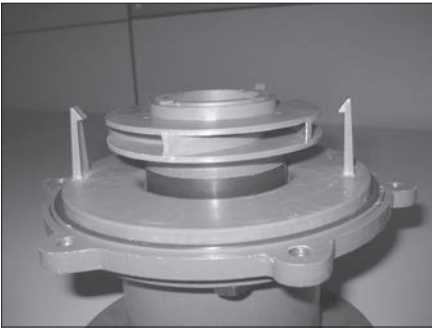

Figure 35

8. Install the inner volute (item 7) by lining up the prongs of the barrier with the channels in the inner volute. Press down evenly until the prongs snap onto the surface of the inner volute. See figures 36 and 37.

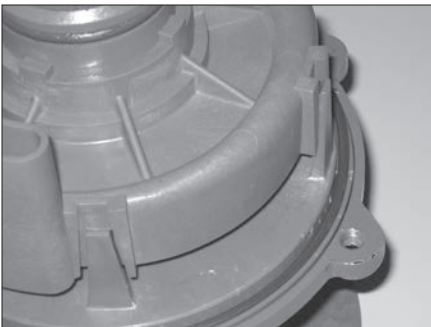

Figure 36



Figure 37

9. Install the separator plate (item 6) by lining up the bottom opening of the inner volute with the opening in the plate. Line up the slots in the separator plate with the notches in the inner volute. See figure 38.
10. If the inner volute o-ring was removed previously, lubricate the inner volute o-ring (item 5) with a chemically compatible lubricant, and install it in the groove on the round suction nozzle in the center of the inner volute. See figure 39.

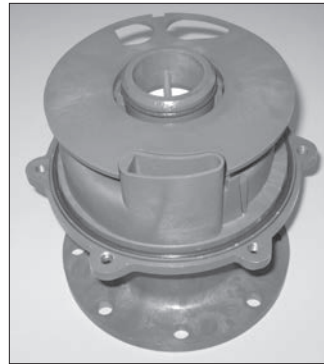

Figure 38

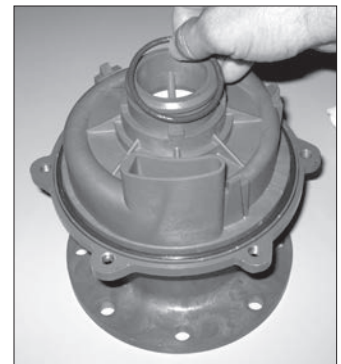

Figure 39

11. After lubricating inside of gooseneck, install the housing (item 1). Line up the tab on the top of the separator plate with the notch in the housing (located inside the front of the housing near the discharge port). Using uniform pressure, press the housing into place until it is flush with the motor adapter. See figure 40. Install the housing bolts, lock washers and flat washers (items 19, 20 & 21). Tighten all bolts evenly using a star pattern. Tighten to 5 foot-lbs (6.8 N-m). Note: If bolt holes do not line up, it may be necessary to tap the housing into place with a rubber mallet. If still unable to line up the bolt holes, then disassemble the pump down to the barrier and start over from step 4.



Figure 40

12. Reinstall the pump on the motor/drive magnet following instructions found in "Assembly, Pumps Without Motors," steps 7-10.

Section VII - Troubleshooting

General Notes:

- Cold water can contain dissolved air. Under high lift applications, the air can come out of solution blocking suction passages. This can lead to lack of priming, slow priming, or low flow rates.
- Do not pump liquids containing ferrous metal fines.
- If magnets decouple, stop pump immediately. Operating the pump with the magnets decoupled will eventually weaken the magnets.
- Do not use mismatched drive magnet assemblies (different number of magnets on inner and outer drive magnet assemblies).
- Contact our Technical Service Department by phone at 800-888-3743 or by e-mail at techservice@finishthompson.com if you have any questions regarding product operation or repair.

No or Insufficient Discharge

- Air leaks in suction piping
- Housing not filled with priming fluid
- Suction pipe smaller than 1"
- Suction pipe contains high spots causing trapped air pockets
- Suction pipe excessively long (flow drops as suction pipe gets longer)
- System head higher than anticipated
- Closed valve
- Viscosity or specific gravity too high
- Motor too large for magnet coupling rating (magnets uncoupled)
- Clogged suction line, suction strainer (if used), or impeller vanes

Insufficient Pressure

- Air or gas entrained liquid
- Impeller diameter too small
- System head lower than anticipated
- Motors speed insufficient (too low) or motor rotation incorrect (correct rotation when viewed from the fan end is clockwise)

Won't Prime

- Did not fill housing with fluid before initially starting pump
- Closed discharge valve (valve should be open or open air vent line)

- Leak in suction piping
- Suction pipe not submerged enough (causing a vortex or exposing the end of the suction pipe)
- Lift exceeds pump ability (see Capabilities section)
- Suction pipe diameter too large
- Specific gravity or local atmospheric pressure (altitude/elevation) not accounted for in lift calculations
- Mis-match of inner volute and impeller diameter
- Inner volute o-ring chemically attacked, cut, brittle, etc.
- Motor rotation incorrect (correct rotation when viewed from the fan end is clockwise)
- Check valve installed too close to the pump

Primes Slowly

- Mismatch of inner volute and impeller diameter
- Suction pipe diameter too large (larger than 1" or 1½")
- Closed discharge valve (valve should be open)
- Inner volute o-ring chemically attacked, cut, brittle, etc.

Excessive Power Consumption

- Head lower than rating
- Excessive flow
- Specific gravity or viscosity too high

Vibration/Noise

- Loose magnet
- Drive magnet rubbing
- Pump cavitating from improper suction or feed
- Motor or piping not properly secured
- Foreign object in impeller

Section VIII - Warranty

Finish Thompson, Inc (manufacturer) warrants this pump product to be free of defects in materials and workmanship for a period of five years from date of purchase by original purchaser. If a warranted defect, which is determined by manufacturer's inspection, occurs within this period, it will be repaired or replaced at the manufacturer's option, provided (1) the product is submitted with proof of purchase date and (2) transportation charges are prepaid to the manufacturer. Liability under this warranty is expressly limited to repairing or replacing the product or parts thereof

and is in lieu of any other warranties, either expressed or implied. This warranty does not apply to normal wear of the product or components. This warranty does not apply to products or parts broken due to, in whole or in part, accident, overload, abuse, chemical attack, tampering, or alteration. The manufacturer accepts no responsibility for product damage or personal injuries sustained when the product is modified in any way. If this warranty does not apply, the purchaser shall bear all cost for labor, material and transportation.

Manufacturer shall not be liable for incidental or consequential damages including, but not limited to process down time, transportation costs, costs associated with replacement or substitution products, labor costs, product installation or removal costs, or loss of profit. In any and all events, manufacturer's liability shall not exceed the purchase price of the product and/or accessories.

Ordering Spare Parts

Spare parts can be ordered from your local distributor. Consult FTI's web site, www.finishthompson.com, to find the nearest local distributor. Always refer to the pump model to avoid error.

Section IX - Spare Parts

1. Select base model (e.g. SP10P)
2. If standard components are not suitable, enter symbol(s) of alternative components in any order.

Base Model - _ _ - _ - _

SP10P E - Ff - 14

SP10P-E-Ff-14 is a SP10 polypropylene construction with EPDM o-ring, fiberglass flanges and 145TC motor adapter.

3. Where standard components aren't suitable, add the alternative component code letter after the base model number to substitute components. (See adjacent list of alternative components.)

The model number appears on the serial number label located on the motor adapter. The model number contains a base model that features certain standard components. Compare the model number on the pump to the adjacent chart to determine if the pump contains any alternate components. Model numbers containing "P" have primary components molded from polypropylene. Model numbers containing "V" have primary components molded from PVDF.

Base model numbers are: SP10P and SP10V.

Model Number Explanation

BASE MODEL COMPONENTS		ALTERNATIVE COMPONENTS		Code						
Bushing	Graphite Carbon	PTFE		T						
		Alumina Ceramic		R						
O-Ring	Viton	EPDM		E						
Connection	NPT	BSP Threads		B						
		Union		U						
		Steel enforced flange		Fs						
		Fiberglass enforced flange		Ff						
Impeller	1	<table border="1"> <tr> <td>2</td> <td>3</td> <td>4</td> <td>5</td> <td>6</td> <td></td> </tr> </table>			2	3	4	5	6	
2	3	4	5	6						
Magnet	10-pole only	No alternatives available. A 10-pole will handle up to a 2 Hp motor.								
Motor Adapter	56C NEMA	145TC NEMA		14						
		IEC 63/B14		64						
		IEC 71/B14		74						
		IEC 80/B14		84						
		IEC 90/B14		94						
		IEC 63/B5		65						
		IEC 71/B5		75						
		IEC 80/B5		85						
IEC 90/B5		95								
Specials	SS hardware, PTFE/ceramic thrust rings, ceramic shaft, Buna o-ring vapor protection kit option (NEMA only)	SiC bushing, thrust ring, shaft		Si						
		Hastelloy shaft		Hs						
		Titanium hardware		Ti						
		Viton o-ring vapor protection kit (NEMA only)		Vv						
		EPDM o-ring vapor protection kit (NEMA only)		Ve						
		Non-sparking ring		Ns						
Motor	Not Standard	Select Motor Reference Number from SP Series Price Book.								

SP10 SPARE PARTS DIAGRAM

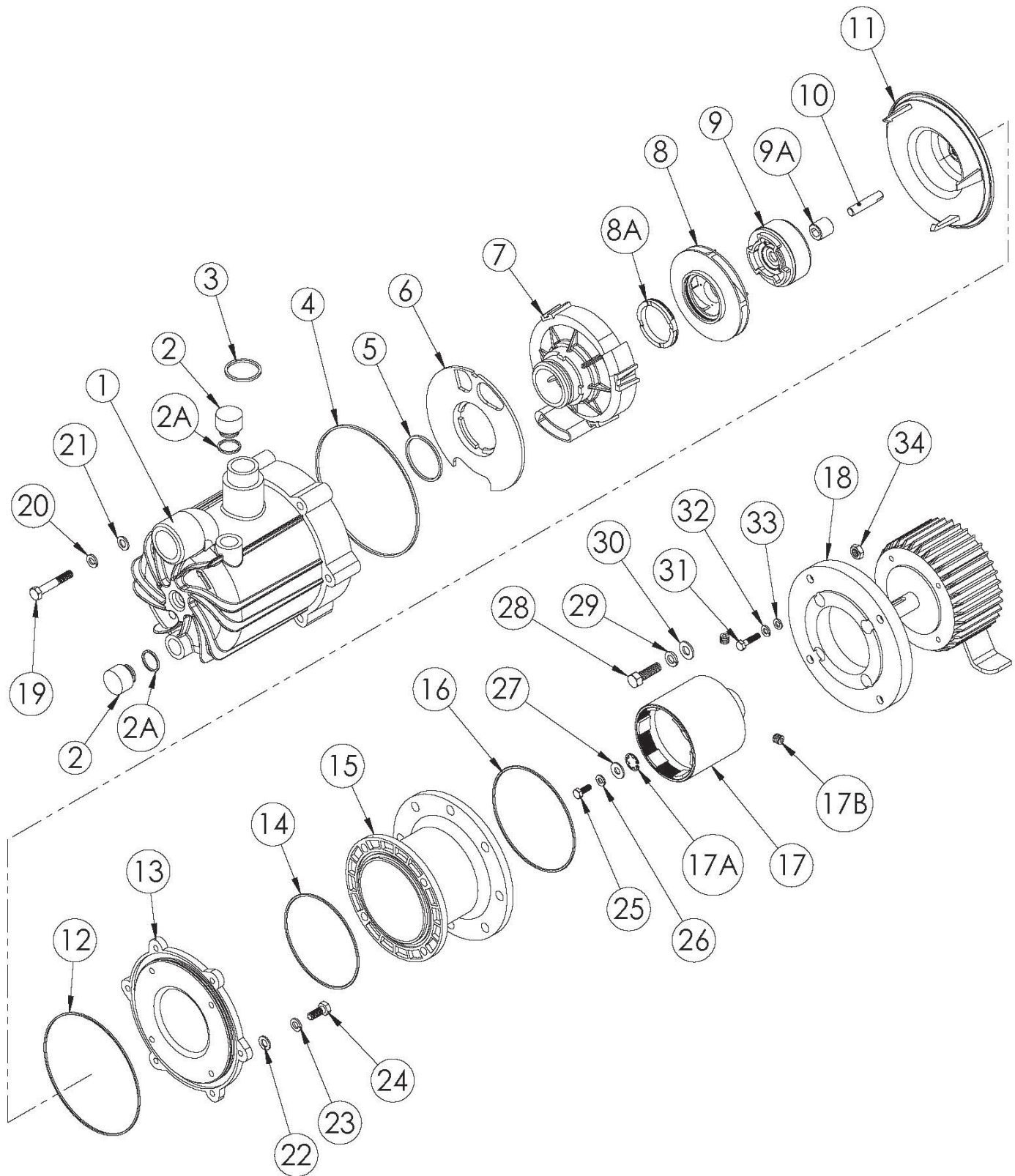

SP10 Spare Parts List

Item	Qty	Description	Pump Material	
			Polypropylene	PVDF
1	1	Housing		
		NPT Threads	106564	106564-1
		BSP Threads	106564-2	106564-3
		Steel Flanges	106964-1	106964-3
		Fiberglass Flanges	106964	106964-2
		Unions	106965	106965-1
2	2	Fill/Drain Plug		
			106143	106143-1
2A	2	Fill Plug O-Ring		
		EPDM		106154
		FKM		106155
3	1	Discharge O-Ring (BSP Housings Only)		
		EPDM		106304
		FKM		106303
4	1	Housing O-Ring		
		EPDM		106299
		FKM		106298
5	1	Inner Volute O-Ring		
		EPDM		106976
		FKM		106975
6	1	Separator Plate		
			106563	106563-1
7	1	Inner Volute (Select Appropriate Impeller Diameter)		
		4.18" (#1) impeller w/ standard alumina ceramic ring	106568-2	106568-3
		4.00" (#2) impeller w/ standard alumina ceramic ring	106568-4	106568-5
		3.75" (#3) impeller w/ standard alumina ceramic ring	106568-6	106568-7
		3.50" (#4) impeller w/ standard alumina ceramic ring	106568-8	106568-9
		3.25" (#5) impeller w/ standard alumina ceramic ring	106568-10	106568-11
		3.00" (#6) impeller w/ standard alumina ceramic ring	106568	106568-1
		4.18" (#1) impeller w/ optional silicon carbide ring	106963-2	106963-3
		4.00" (#2) impeller w/ optional silicon carbide ring	106963-4	106963-5
		3.75" (#3) impeller w/ optional silicon carbide ring	106963-6	106963-7
		3.50" (#4) impeller w/ optional silicon carbide ring	106963-8	106963-9
		3.25" (#5) impeller w/ optional silicon carbide ring	106963-10	106963-11
		3.00" (#6) impeller w/ optional silicon carbide ring	106963	106963-1
		8	1	Impeller Assembly
4.18" (#1) impeller w/ standard PTFE thrust ring	106352			106352-1
4.00" (#2) impeller w/ standard PTFE thrust ring	106352-2			106352-3
3.75" (#3) impeller w/ standard PTFE thrust ring	106352-4			106352-5
3.50" (#4) impeller w/ standard PTFE thrust ring	106352-6			106352-7
3.25" (#5) impeller w/ standard PTFE thrust ring	106352-8			106352-9
3.00" (#6) impeller w/ standard PTFE thrust ring	106352-10			106352-11
4.18" (#1) impeller w/ optional silicon carbide thrust ring	106353			106353-1
4.00" (#2) impeller w/ optional silicon carbide thrust ring	106353-2			106353-3
3.75" (#3) impeller w/ optional silicon carbide thrust ring	106353-4			106353-5
3.50" (#4) impeller w/ optional silicon carbide thrust ring	106353-12			106353-13
3.25" (#5) impeller w/ optional silicon carbide thrust ring	106353-8			106353-9
3.00" (#6) impeller w/ optional silicon carbide thrust ring	106353-10			106353-11
8A	1			Impeller Thrust Ring Only
		PTFE		106257
		SiC		106257-1

SP10 Spare Parts - continued

Item	Qty	Description	Pump Material		
			Polypropylene	PVDF	
9	1	Impeller Drive			
		6-pole w/ carbon bushing	106361	106361-3	
		8-pole w/ carbon bushing	106361-1	106361-4	
		10-pole w/ carbon bushing	106361-2	106361-5	
		6-pole w/ silicon carbide bushing	106361	106362-3	
		8-pole w/ silicon carbide bushing	106362-1	106362-4	
		10-pole w/ silicon carbide bushing	106362-2	106362-5	
		6-pole w/ alumina ceramic bushing	106363	106363-3	
		8-pole w/ alumina ceramic bushing	106363-1	106363-4	
		10-pole w/ alumina ceramic bushing	106363-2	106363-5	
		6-pole w/ PTFE bushing	106364	106364-3	
		8-pole w/ PTFE bushing	106364-1	106364-4	
10-pole w/ PTFE bushing	106364-2	106364-5			
9A	1	Impeller Bushing Only			
		Carbon	J102387		
		PTFE	J102790		
		Ceramic	J103617		
		SiC	J103617-1		
10	1	Impeller Shaft			
		Ceramic	106293		
		SiC	106293-1		
		Hastelloy C	106293-2		
11	1	Barrier			
		With silicon carbide thrust washer	106235-6	106235-7	
12	1	Barrier O-ring (NEMA motors only)			
		Buna	106572		
		EPDM	106550		
		FKM	106551		
13	1	Clamp Ring			
		Painted cast iron (Standard)	106246	106246-1	
		Painted cast iron with non-sparking ring	106521	106521-1	
		Stainless steel	108599	108599	
		Stainless steel with non-sparking ring	108599-1	108599-1	
14	1	Clamp Ring O-ring (NEMA Motors only)			
		Buna	106548		
		EPDM	106372		
		FKM	J103954		
15	1	Motor Adapter			
			106248	106248-1	
16	1	Motor Adapter O-ring (NEMA Motors only)			
		Buna	106549		
		EPDM	106373		
		FKM	106374		

SP10 Spare Parts - continued

Item	Qty	Description	Pump Material		
			Polypropylene	PVDF	
17	1	Drive Magnet Assembly with Retaining Ring (56C frame also includes set screws)			
		56C frame, 6-pole		106283	
		56C frame, 8-pole		106283-1	
		56C frame, 10-pole		106283-2	
		143/145TC frame, 8-pole		106283-4	
		143/145TC frame, 10-pole		106283-5	
		63 frame, 6-pole		106289	
		63 frame, 8-pole		106289-1	
		63 frame, 10-pole		106289-2	
		71 frame, 6-pole		106286	
		71 frame, 8-pole		106286-1	
		71 frame, 10-pole		106286-2	
		80 frame, 8-pole		106292-1	
		80 frame, 10-pole		106292-2	
		90 Frame, 10-pole		106292-5	
17A	1	Retaining Ring Only			
		56C frame		105708	
		143/145TC frame		105709	
		63 frame		106310	
		71 frame		106309	
		80 frame		105711	
		90 frame		105712	
17B	2	Set Screws			
		NEMA Motors Only		J101084	
18	1	Motor Adapter Flange (IEC Motors Only)			
		63/71 frame w/ B14	106271	106271-1	
		80 frame w/ B14	105724-1	105724-2	
		90 frame w/ B14	105725-1	105725-2	
		63 frame w/ B5	106272	106272-1	
		71 frame w/ B5	106273	106273-1	
		80/90 frame w/ B5	106274	106274-1	

Hardware - All SP10 Models				
Item	Qty	Description	Stainless Steel	Titanium
19	6	Housing Bolt		
			J102789	106308
20	6	Housing Lock Washer		
			J102282	J103847
21	6	Housing Flat Washer		
			105767	105768
22	4	Clamp Ring Flatwasher		
			105767	105768
23	4	Clamp Ring Lockwasher		
			J102282	J103847
24	4	Clamp Ring Bolt		
			105770	105770
25	1	Drive Bolt (IEC Only)		
		63 Frame	106314	106315
		71 Frame	106312	106313
		80 Frame	105765	105766
		90 Frame	105770	105771
26	1	Drive Lock Washer (IEC Only)		
		63 Frame	106322	106323
		71 Frame	106320	106321
		80 Frame	J100672	J104203
		90 Frame	J102282	J103847
27	1	Drive Flat Washer (IEC Only)		
		63 Frame	106318	106319
		71 Frame	106316	106317
		80 Frame	105767	105768
		90 Frame	105722	105773
28	4	Motor Adapter Bolt		
			J100114	106311
29	4	Motor Adapter Lock Washer		
			J100115	J104206
30	4	Motor Adapter Flat Washer		
			J100128	J104207
31	4	Motor Adapter Flange Bolt (IEC Only)		
		63 Frame	106348	106349
		71 Frame	105765	105766
		80 Frame	105765	105766
		90 Frame	105770	105771
32	4	Motor Adapter Lock Washer (IEC Only)		
		63 Frame	J103637	106350
		71 Frame	J100672	J104203
		80 Frame	J100672	J104203
		90 Frame	J102282	J103847
33	4	Motor Adapter Flat Washer (IEC Only)		
		63 Frame	J103638	106351
		71 Frame	J100113	J104204
		80 Frame	J100113	J104204
		90 Frame	J101293	J103845
34	4	Motor Adapter Nut (IEC Only)		
		63 & 71 Frame with B14 Flange	108141	n/a



FINISH THOMPSON INC.

921 Greengarden Road • Erie, PA 16501-1591 U.S.A.
Ph 814-455-4478 • Fax 814-455-8518

Email fti@finishthompson.com • www.finishthompson.com

Part Number 107009,R11, 2/14/2014

Order fax: 814-459-3460

Tech Service: 800-888-3743

